

TERMS & CONDITIONS

1. The maps data and/or preloaded software (“Software”) in this device are licensed by third parties to Amtel Cellular Sdn Bhd (“The Company”). The Software is sub-licensed on a limited, non-exclusive, non-transferable and revocable basis for use by you solely on this device only and is not sold together with the device. If upgrades, updates or supplements to the Software are obtained, the use of such upgrades, updates or supplements is governed by these Terms and Conditions and any amendments that may accompany them and may be subject to additional payments and conditions. You must not reproduce, distribute, publish, transmit, modify, adapt, translate, display, distribute, sell, license, publicly perform, prepare derivative works based upon, or otherwise use or exploit the Software. The foregoing limited right does not give you any ownership of Software and nothing contained in this Agreement may be construed as conferring to you any licence or right to the Software under any copyright or any other intellectual property right.
2. The Software is provided by the copyright holders "AS IS" and any express or implied warranties, including, but not limited to, the implied warranties of merchantability and fitness for a particular purpose, are disclaimed. In no event shall the copyright owner be liable for any direct, indirect, incidental, special, exemplary, or consequential damages however caused and on any theory of liability, whether in contract, strict liability, or tort (including negligence or otherwise) arising in any way out of the use of the Software, even if advised of the possibility of such damage. The entire risk to the quality and performance of the Software is borne by you. This disclaimer of warranty constitutes and essential part of the licence granted to you to use the Software.
3. The trademarks, logos, and service marks (“Trademark”) displayed on this Software and device, are owned by the Company and third parties. All Trademarks not owned by the Company are the property of their respective owners, and are used with permission. Nothing contained herein may be construed as granting any right or license to use any Trademark.
4. The maps and any information stored in this device is strictly a navigation guide for reference use only. It is the sole responsibility of the User’s to use this device prudently. Information provided may change over time and you should decide the route based on the actual road conditions and traffic laws. The Company makes no representation or warranty, whether expressly or impliedly as to the accuracy, completeness, timeliness, reliability or fitness for any particular purpose of the maps stored therein.
5. The planned, shortest, quickest routes and estimated time to desired destinations are obtained from optimal route calculations based on the map database and should be used as a reference only. This device must not be used for any purpose requiring precise measurement of direction, distance, location or topography.

6. Do not fix or mount the device on such part of the windscreen that will interfere with driving of the motor vehicle or be hazardous or dangerous to the driver or occupants in the motor vehicle. User shall be responsible for his/her use of the maps stored therein and the device, and shall at all times comply with all traffic laws and regulations of the country of usage.
7. The usage of this device is dependent on the Global Positioning System (GPS) which is operated by the United States government and is solely responsible for its accuracy and maintenance. The system is subject to changes which may affect the performance and accuracy of the GPS navigator devices.
8. The use of the device is at the User's own risk. Lokatoo and the Company is not liable for any fines, penalties, damages or loss whether direct, indirect, incidental, special, exemplary, or consequential damages however caused and on any theory of liability, whether in contract, strict liability, or tort (including negligence or otherwise) arising in any way out of the use of the device.

CONTENTS

HARDWARE INTERFACE PANEL	04
REMOTE CONTROL	06
MAIN MENU	10
NAVI	11
RESTART NAVI	11
BLUETOOTH	12
Bluetooth menu	12
Key pad page	13
Recent calls page	14
Bluetooth setup page	15
Bluetooth music playback interface page	16
DVD	17
Playing music files	17
Playing audio CD	17
Playing MP3 files	19
Playing movie files	20
Playing DVD / VCD	20
Playing AVI files	20
Viewing picture files	21
Media Playback Menu Buttons	23
Spectrum Display	30
VIR.CDC	31
Ripping an audio CD to the system internal hard disk	32
RADIO	34
SET	35
System setup	35
Video setup	37
Audio setup	38
Time setup	40
Adjusting the time	40
Control setup	41
Connection Diagram	42
Multi-function compound interface	43
Specifications	44

HARDWARE INTERFACE PANEL

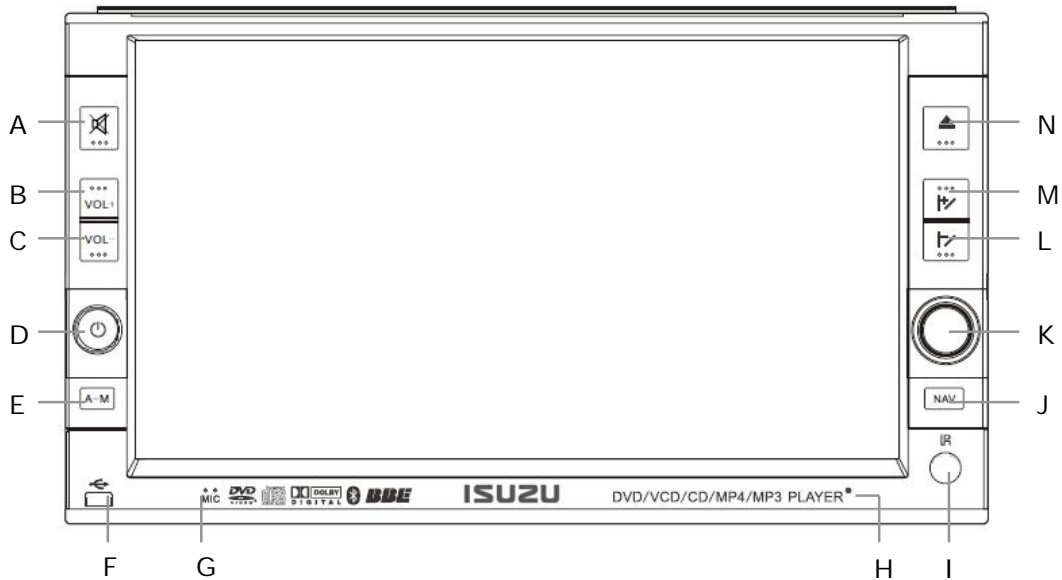

- A. Mute. Press this button to enable the system to enter mute mode. Press again to disable it.
- B. Press to increase the volume.
- C. Press to decrease the volume.
- D. On / Off. Press to switch on the system.
If the system is on, press once and the system will enter night mode with dimmer screen display. Press again and the system will turn off the screen. Press again to go back to the original state.
Press and hold for 2 seconds to turn off the system.
- E. Press to select audio mode (equalizer mode).
- F. USB port to connect to USB flash drive.
- G. Microphone. For Bluetooth handsfree communication.
- H. Reset to factory setups.
- I. Infrared port. For remote control communication.
- J. Switches between navigation screen and other system functions.

K.	Playing music or movie files (including VIR.CDC)	Viewing picture files	Radio
Up	Fast reverse	N/A	Manual tuning (frequency in descending order)
Down	Fast forward	N/A	Manual tuning (frequency in ascending order)
Press	N/A	N/A	Save frequency as station
Left	Play previous track	View previous picture	Go previous station
Right	Play next track	View next picture	Go next station

L. Tilt screen (down)

M. Tilt screen (up)

N. Eject or take in disc.

To switch to disc playback mode from other functions.

You may also tilt the screen by pressing the screen as shown below. Behind the screen, you will find slots for SDMMC card.

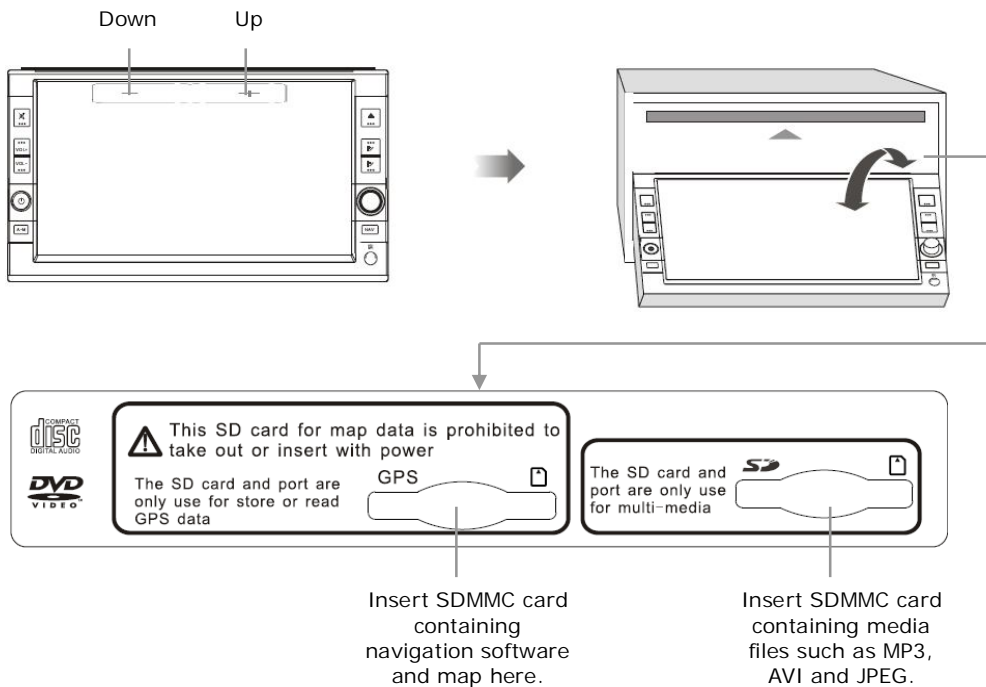

REMOTE CONTROL

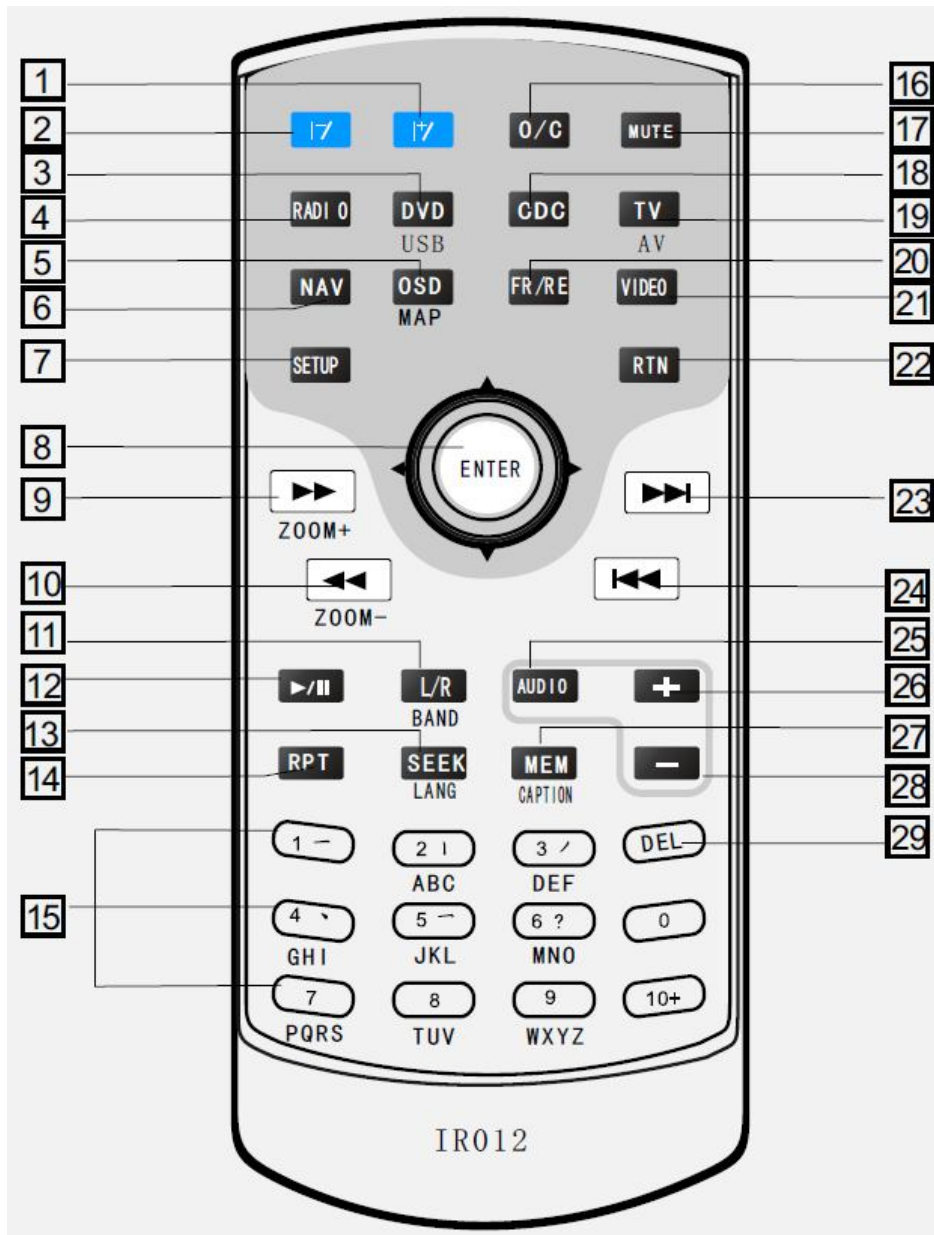

1. Tilt screen (up)
2. Tilt screen (down)
3. Media playback interface. Plays music, movie and viewing picture from CD, DVD, SDMMC card or USB flash drive.
4. Radio interface
5. To display information on time elapsed and remain when playing movie.

6. Switches between navigation screen and other system functions.
7. Press to enter and exit setup menu page.
8. In file listing page, press up▲ or down▼ to highlight file. Press left◀ to page up and right▶ to page down. Press Enter to select the file. For individual function, please refer to the table below.

	VIR.CDC	Viewing picture files	Radio
Up▲	N/A	Flip picture vertical	Manual tuning (frequency in descending order)
Down▼	N/A	Flip picture horizontal	Manual tuning (frequency in ascending order)
Enter	N/A	N/A	Save tuned frequency as station
Left◀	Fast reverse	Rotate picture anti-clockwise	Go previous station
Right▶	Fast forward	Rotate picture clockwise	Go next station

* Not applicable for movie and music playback.

9.

	Playing music or movie files (including VIR.CDC)	Viewing picture files	Radio
Fast forward		N/A	Auto tuning (frequency in ascending order)

10.

	Playing music or movie files (including VIR.CDC)	Viewing picture files	Radio
Fast reverse		N/A	Auto tuning (frequency in descending order)

11.

Playing DVD	Playing VCD, AVI files	Radio
To switch DVD language selection. (Disc support dependent)	To switch audio mode between Left Mono, Right Mono, Mix-Mono and Stereo	To select the frequency band.

12. Play / pause

13.

Playing DVD	Playing VCD, AVI files	Radio
To switch DVD language selection. (Disc support dependent)	To switch audio mode between Left Mono, Right Mono, Mix-Mono and Stereo	Search stations and save automatically.

14. Repeat playback setup. You may choose to repeat a single track or all tracks.

15. Numeric keyboard. For keying in track / file number to be played / viewed.

16. To tilt down / up screen.

17. Mute. Press this button to enable the system to enter mute mode. Press again to disable it.

18. Press to enter VIR.CDC mode. Please refer page 31 for details.

19. * *This function is not available.*

20. * *This function is not available.*

21. * *This function is not available.*

22.

Playing DVD	Playing VCD	Playing AVI files	Viewing picture files
Return to DVD title menu page.	To turn on / off PBC (Playback control) feature.	Return to file listing page.	1 st press – Display picture in thumbnail. 2 nd press – Display file listing page.

23.

Playing music or movie files (including VIR.CDC) or viewing picture files	Radio
Play next track / file	Go to next station.

24.

Playing music or movie files (including VIR.CDC) or viewing picture files	Radio
Play previous track / file	Go to previous station.

25. Tap to select the desired equalizer mode between FLAT, CUSTOM, POP, ROCK, CLASSIC and JAZZ.

26. Increase volume

27. Decrease volume

28.

Playing DVD	Radio
To switch DVD language selection. (Disc support dependent)	Save tuned frequency as station.

29. * *This function is not available.*

MAIN MENU

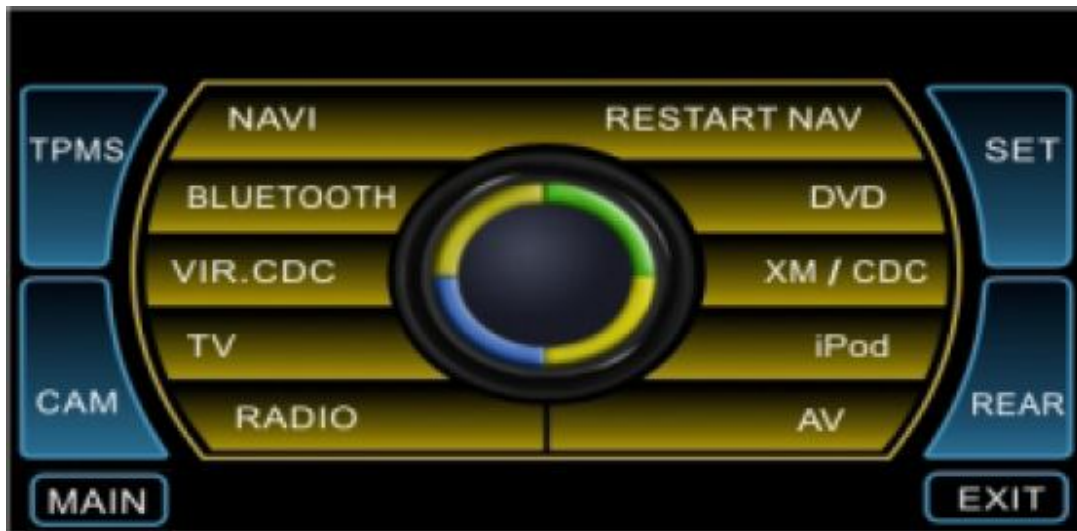

- | | | |
|-----|--------------------|--|
| 1. | NAVI | Tap this icon to launch the navigation software. Please refer Lokatoo Navigation Software User Manual. |
| 2. | RESTART NAV | Tap this icon to re-launch the navigation software. |
| 3. | BLUETOOTH | Handsfree functions for your mobile phone. |
| 4. | DVD | Plays music, movie and viewing picture from CD, DVD, SDMMC card or USB flash drive. |
| 5. | VIR.CDC | Virtual CD changer. To play ripped audio CD music from the device internal memory. |
| 6. | XM / CDC | <i>* This function is not available.</i> |
| 7. | TV | <i>* This function is not available.</i> |
| 8. | iPod | <i>* This function is not available.</i> |
| 9. | RADIO | Tune and listening to FM or AM band radio. |
| 10. | AV | <i>* This function is not available.</i> |
| 11. | TPMS | <i>* This function is not available.</i> |
| 12. | SET | Device setup page. |
| 13. | CAM | <i>* This function is not available.</i> |
| 14. | REAR | <i>* This function is not available.</i> |
| 15. | MAIN | Return to Main Menu. |
| 16. | EXIT | Return to previous function. |

NAVI

Tap this icon to launch the navigation software. (Please refer to the navigation software user manual)

RESTART NAVI

Tap this icon to re-launch the navigation software. Only select this option if you experience unusual response from the navigation software.

BLUETOOTH

The Bluetooth function allows the GPS In built navigator to be paired to a mobile phone for making and answering calls. You may also play music from your mobile phone and connect it to your car sound system via Bluetooth.

Before Bluetooth can be used, both devices need to be matched (Paired). Press **Pairing** from the Bluetooth Setup page menu screen to begin pairing process, then, search for Bluetooth equipment (which is your GPS In built navigator in this case) from your mobile phone. Once the Bluetooth equipment (navigator) is found, enter the pairing password (Default: 0000), if asked. You can change the password in the Bluetooth Setup page. Once the pairing is successful, establish the connection from your mobile phone. Otherwise, repeat the pairing steps.

Bluetooth menu



Key pad page – To access the key pad for making call.

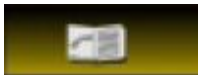

Recent calls page – List down outgoing, incoming and missed calls details.



Bluetooth setup page



Bluetooth music playback interface page



To dial the phone number in Recent calls page

Note

To use the Bluetooth function, ensure that your mobile phone has Bluetooth capability and its function is enabled.

Key pad page

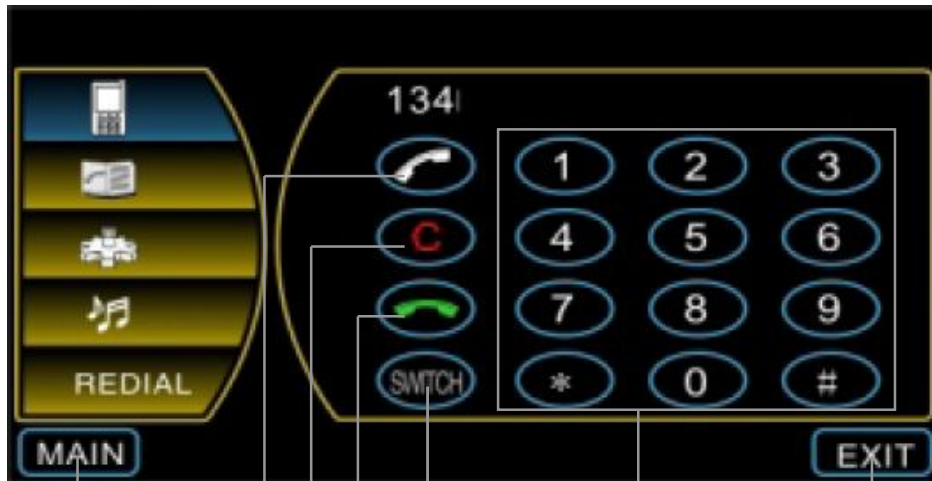

- | | | | |
|----|---------------------------|----|---|
| A. | Return to Main Menu. | E. | Switch between phone or Bluetooth mode during call. |
| B. | To call the dialed number | F. | Numeric key pad |
| C. | Backspace | G. | Return to previous function. |
| D. | End call | | |

To make outgoing call, use the numeric key pad to enter (F) phone number. Then tab (B) to call the dialed number. To end the call, tab (D).

If there is an incoming call, the screen will display image below.

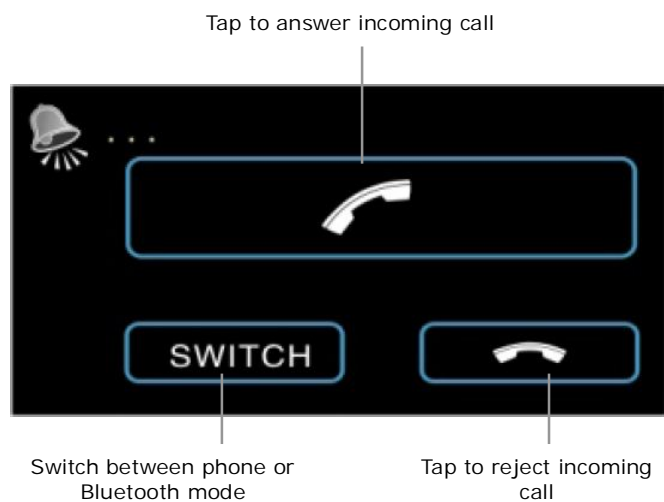

Recent calls page

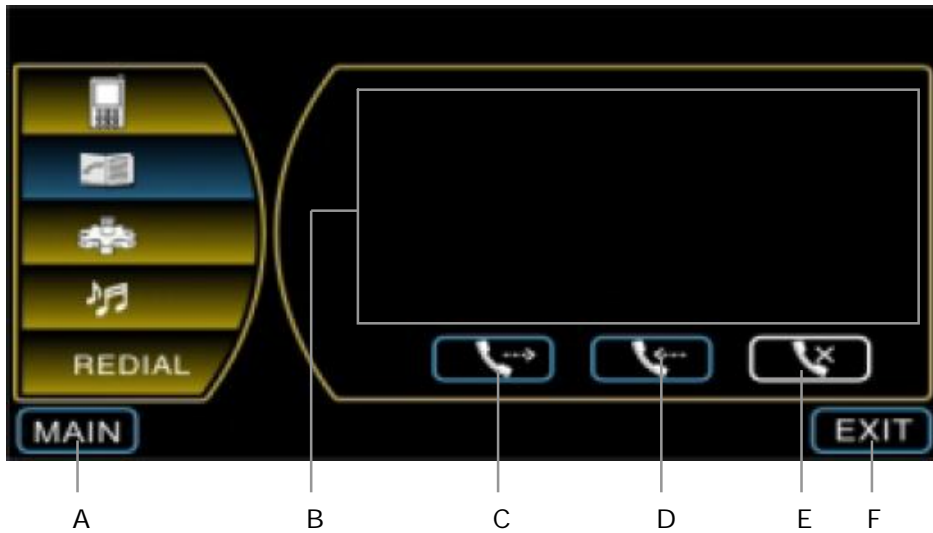

- A. Return to Main Menu.
- B. Calls details display area.
- C. List outgoing calls details.
- D. List incoming calls details.
- E. List missed calls details.
- F. Return to previous function.

Recent calls page can list up to 5 outgoing, incoming and missed calls respectively. To call the number listed in Recent Calls page, simply tap the contact in the (B) call details display area, then tap **REDIAL**.

Bluetooth setup page

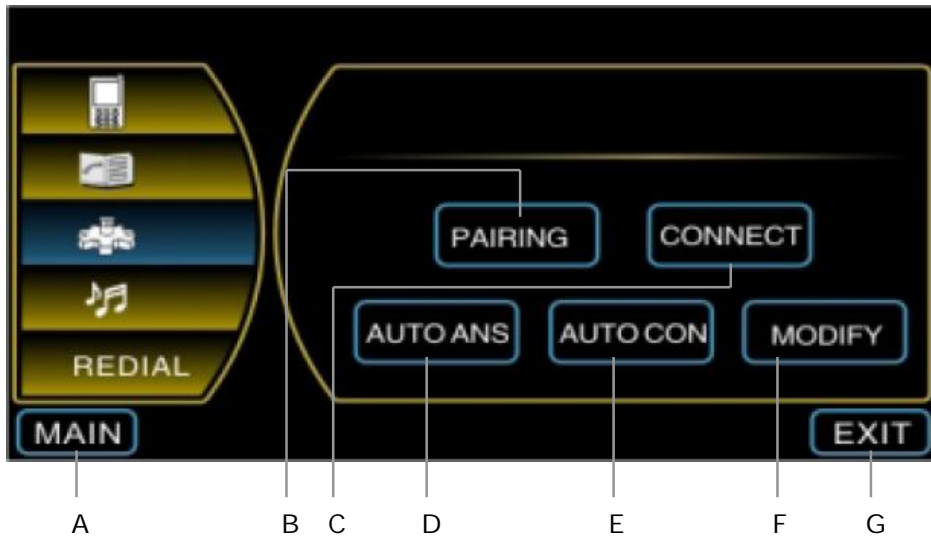

- A. Return to Main Menu.
- B. Tab to activate the Bluetooth function. Then, use your mobile phone to search the GPS In built navigator's Bluetooth profile.
- C. To establish the connection between your mobile phone and the GPS In built navigator once Pairing process is successful.
- D. Tab this button to allow incoming call to enter answer mode automatically after 3 rings without user's intervention.
- E. To allow paired mobile phone to connect to the GPS In car navigator automatically whenever the mobile phone is detected.
- F. To modify pairing password and Bluetooth profile name.

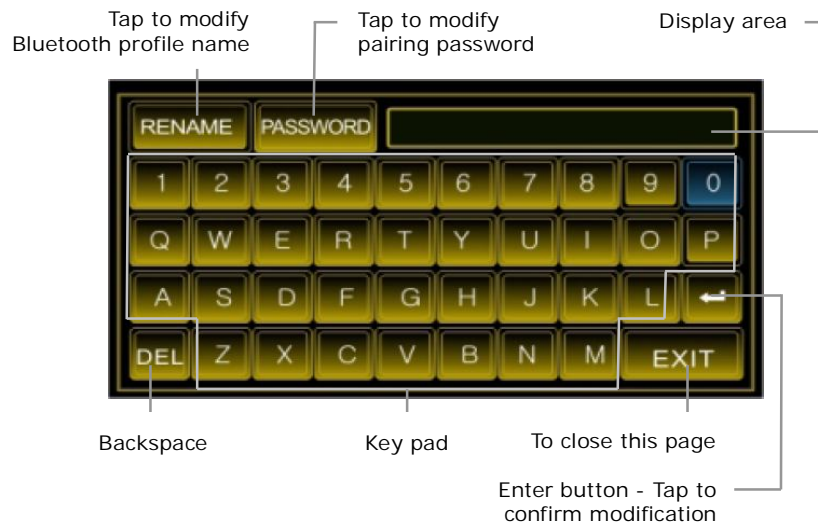

- G. Return to previous function.

Bluetooth music playback interface page

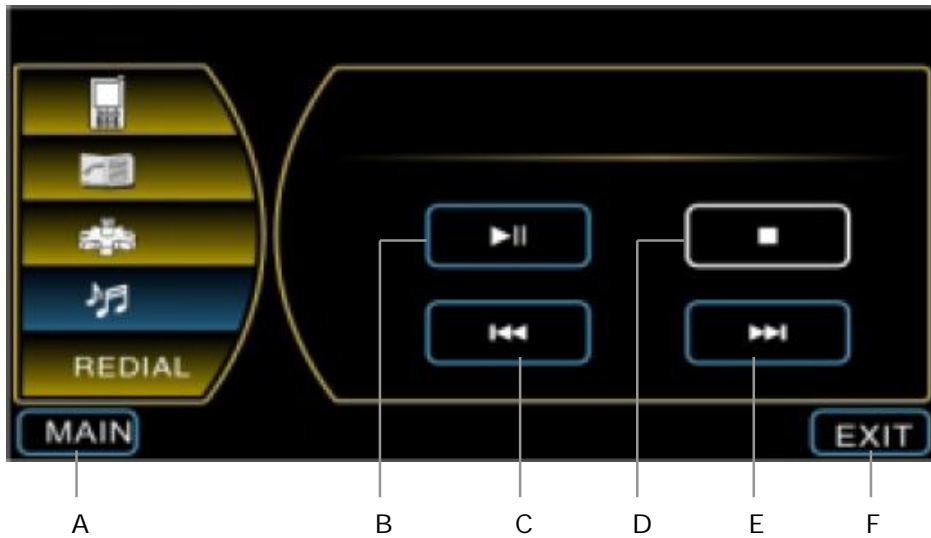

- | | |
|-------------------------|---------------------------------|
| A. Return to Main Menu. | D. Stop |
| B. Playback / Pause | E. Previous track |
| C. Next track | F. Return to previous function. |

To play music via Bluetooth, your mobile phone must be able to support "Play via Bluetooth" capability and its Bluetooth function must be enabled. Next, perform pairing, then, play the music from your phone. At the same time, go to Bluetooth music playback interface page from your GPS In built navigator. Now, you should be able to hear the music being played from your car speaker. You may use the interface (B), (C), (D) and (E) to control the music playback.

DVD

You may play music (audio CD or in MP3 format), movie (DVD, VCD or AVI format) or view picture (JPG) here. These media files may be in the form of DVD, VCD, audio CD, CD-R, SDMMC card or USB flash drive.

Even though the system allows multiple media storage to be inserted to the system, only one media storage can be played at a time.

To switch from one media storage to another, tap **MAIN** at the media playback menu buttons, then tap **DVD**. Repeat this process until the system plays the desired media storage.

If all media storages are inserted to the system, the system will play disc first. If **DVD** is tapped, it will switch to SDMMC card. Tap **DVD** again to switch to USB flash drive. Tap **DVD** again to go back to disc playback.

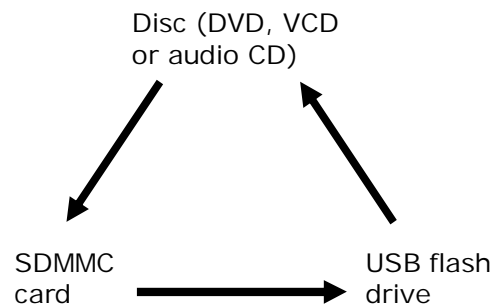

Note

If a disc is inserted to the system while playing file from SDMMC card or USB flash drive, the system will switch to play the disc automatically. However, if the system is playing a disc, inserting an SDMMC card or a USB flash drive will not cause the system to switch away from disc playback. The user will need to tap **MAIN** at the media playback menu buttons, then tap **DVD** in order to allow the system to switch to SDMMC card or USB flash drive.

Playing music files

Playing audio CD

Insert an audio CD to the system and the CD will be played automatically.

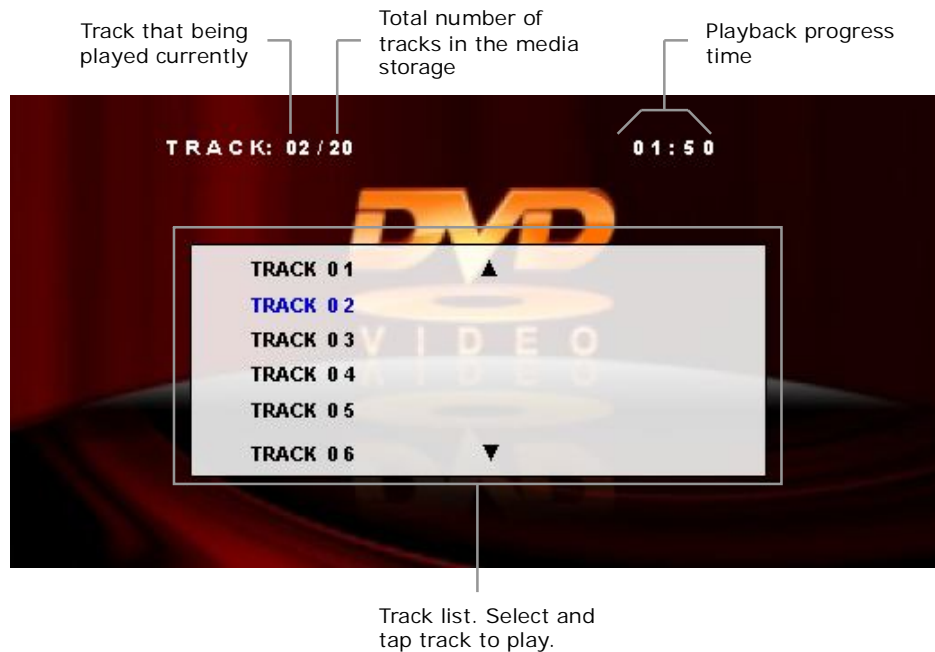

Tap anywhere on the screen above (except the track list) during track playback to display the media playback menu buttons. Please refer to page 23 for media playback menu buttons descriptions.

Note

If "Spectrum" function is enabled, the screen will turn to spectrum display page when it is left idle while playing music for about 12 seconds. Go to page 30 to learn about Spectrum.

Playing MP3 files

MP3 files can be played from DVD, CD, SDMMC card or flash drive. Just insert or connect any of these media storage containing MP3 files to the system and tap  to play the MP3 files.

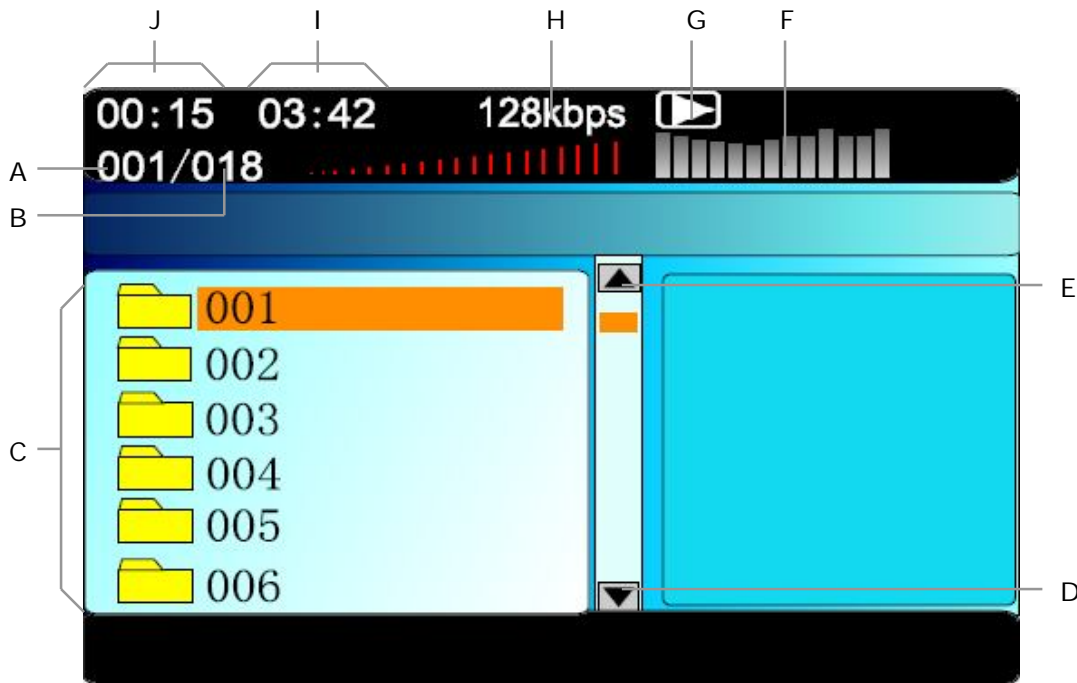

- | | |
|-------------------------------|---------------------------------|
| A. Playback of current track. | F. Mini spectrum |
| B. Total track | G. Playback status |
| C. Track list | H. Audio quality |
| D. Scroll down | I. Total current playback time. |
| E. Scroll up | J. Playback progress time. |

You may choose to play a desire track by tapping the track number at the track list (C).

Tap anywhere on the screen above (except the track list) during track playback to display the media playback menu buttons. Please refer to page 23 for media playback menu buttons descriptions.

Note

If "Spectrum" function is enabled, the screen will turn to spectrum display page when it is left idle while playing music for about 12 seconds. Go to page 30 to learn about Spectrum.

Playing movie files

Playing DVD / VCD

Insert a DVD or VCD to the system and it will be played automatically.

DVD or certain VCD format allows you select the title / chapter. Tap the title / chapter you would like the system to play.

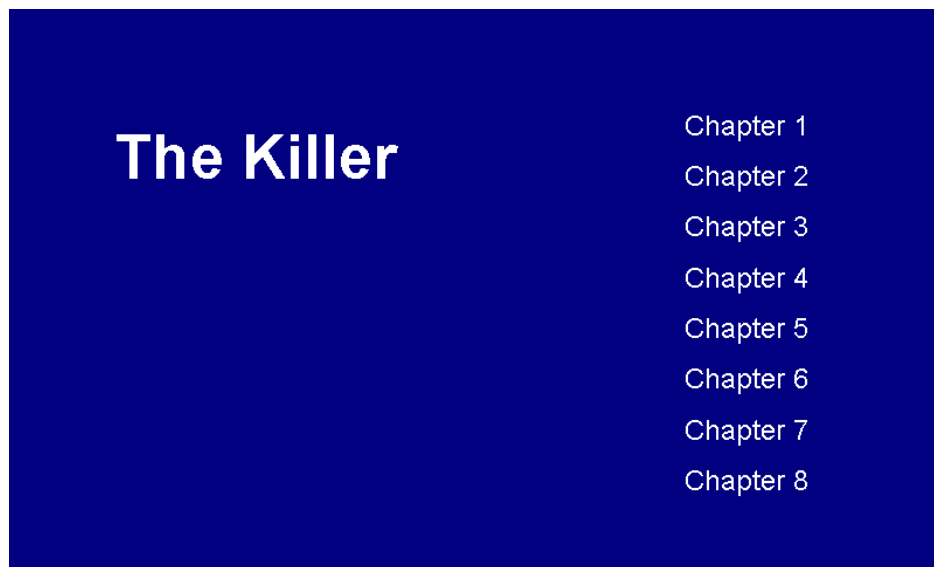

Tap anywhere on the screen during playback to display the media playback menu buttons. Please refer to page 23 for media playback menu buttons descriptions.

Playing AVI files

AVI files can be played from DVD, CD, SDMMC card or flash drive. Just insert or connect any of these media storage containing AVI files to the system and tap  to play these files.

Tap anywhere on the screen during DVD playback to display the media playback menu buttons. Please refer to page 23 for media playback menu buttons descriptions.

Viewing picture files

You can view pictures JPEG stored in DVD, CD, SDMMC card or flash drive. Just insert or connect any of these media storage containing JPEG files to the system and tap  to view the pictures as slide show.



View JPEG files as slide show

Tap anywhere on the screen above during slide show to display the media playback menu buttons. Please refer to page 23 for media playback menu buttons descriptions. (Certain buttons in the media playback menu buttons may not be applicable to picture viewing function)

Tap  at the media playback menu button to display the pictures in thumbnail size as shown below.



Tap  again at the media playback menu button to display the list of the picture files as shown below.

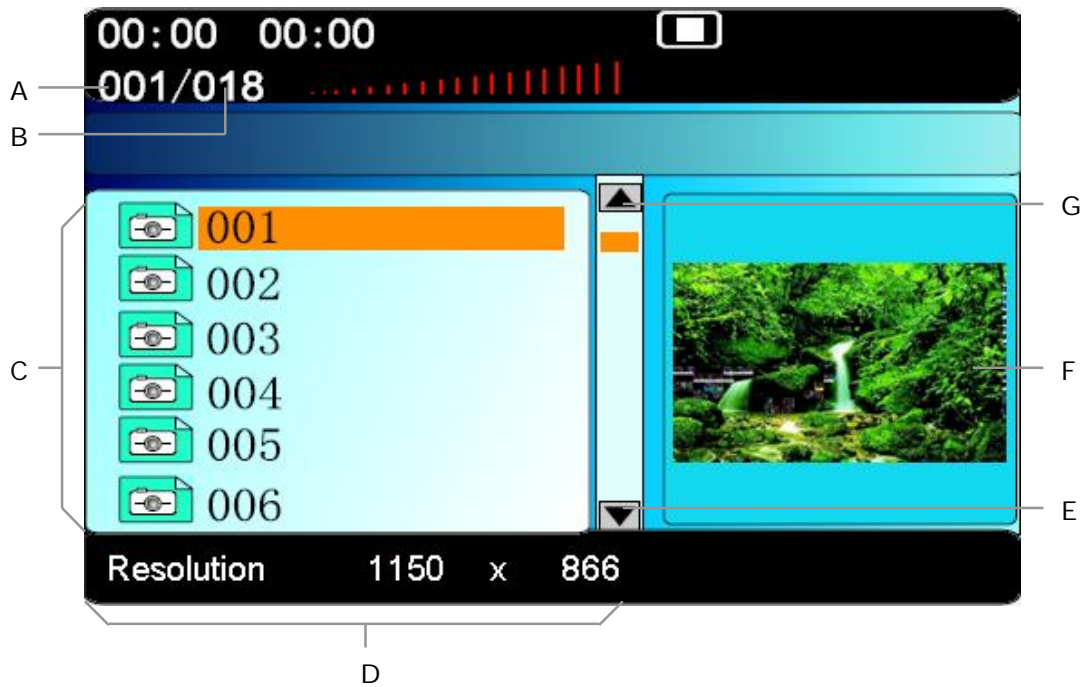

- | | |
|-------------------------------------|-------------------------|
| A. Viewing of current picture file. | D. Picture's resolution |
| B. Total picture files | E. Scroll down |
| C. Picture files list | F. Picture's preview |
| | G. Scroll up |

Media Playback Menu Buttons

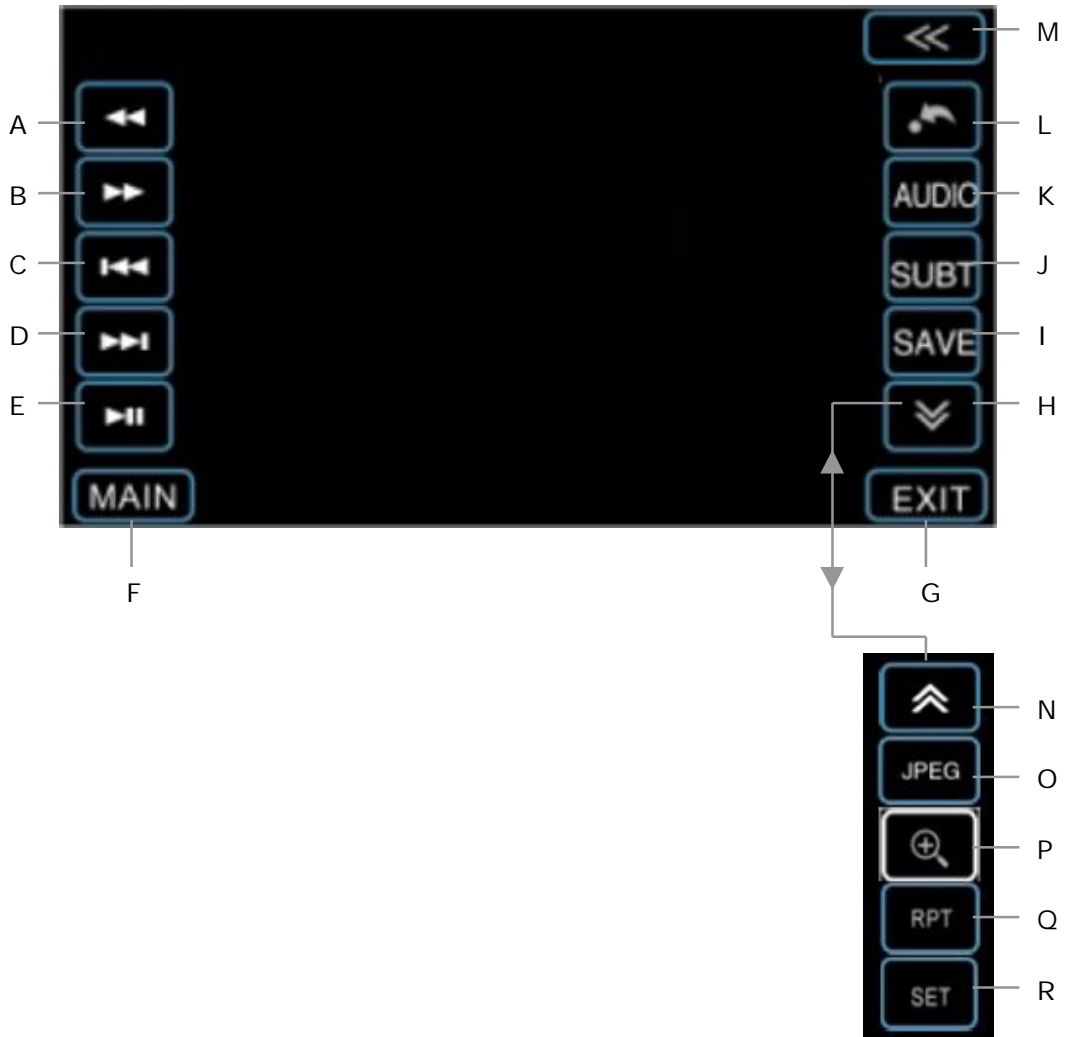





- A. Fast reverse
- B. Fast forward
- C. Previous track / file
- D. Next track / file
- E. Play / pause
- F. Return to Main Menu.
- G. Hide Media Playback Menu Buttons

- H. Menu page down
- I. To rip audio CD to system internal hard disk. Please go to page 32 for details.
- J. To select DVD playback subtitle. (Disc support dependent)
- K. To select DVD playback language. (Disc support dependent)
- L. Tap to go to title / chapter menu for DVD movie and folder page for other media format. For VCD playback, this button will turn on / off the PBC (Playback control)
- M. Tap to display numeric keyboard for track selection.



Numeric keyboard

To play the desired track, key in track number and tap  at the numeric keyboard. To play track number 10 and greater, tap  for the first digit before keying in the second digit.

For example, if you would like to play track number 58, tap  five times. Then, tap .

- N. Menu page up
- O. To capture image when playing movie or viewing picture to be used as wallpaper.
- P. To enlarge or diminish playback display.
- Q. Repeat playback setup. You may choose to repeat a single track or all tracks.

R. Tap to enter / exit media playback setup page.

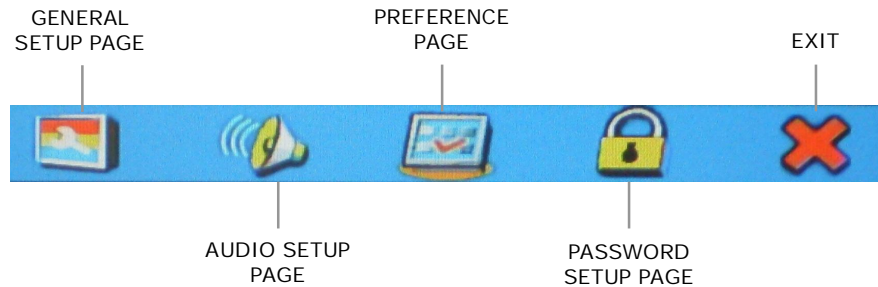

GENERAL SETUP PAGE

TV DISPLAY

NORMAL / PS	"Panorama" display
NORMAL / LB	"Wide screen" (16:9) display
WIDE	"Message box" display

ANGLE MARK

ON	OFF
----	-----

OSD LANG

ENGLISH	FRENCH	SWEDISH
CHINESE	ITALIAN	RUSSIAN

To select media playback interface language.

CAPTIONS

ON	OFF
----	-----

To display / hide subtitle during playback. (Disc support dependent)

SCREEN SAVER

ON	OFF
----	-----

To enable / disable screen saver display when the system is idle for a period of time.

LAST MEMORY

ON	OFF
----	-----

When this feature is turned on, the system will continue the playback of the DVD to the point where it last stopped. If it is off, the system will play the DVD from the beginning.

Logo Type

Default

To use the default logo as background picture.

Captured

To use the captured image as background picture. To learn on how to capture image, please go to page 24.

AUDIO SETUP PAGE

SPEAKER SETUP
(Double tap to enter)

DOWNMIX

LT / RT	Dolby stereo, distributing the sound from the middle and the surround channels to the left and right stereo.
STEREO	During disc is playing, the audio output left and right channel signal.
V SURR	The left and right channels create surround sound effect.
OFF	

FRONT SPEAKER

LARGE	All band speaker
SMALL	Medium or tweeter

To choose the relevant front speaker size.

CENTER SPEAKER

LARGE	All band speaker
SMALL	Medium or tweeter
OFF	

To choose the relevant center speaker size.

REAR SPEAKER

LARGE	All band speaker
SMALL	Medium or tweeter
OFF	

To choose the relevant rear speaker size.

SUBWOOFER

ON	OFF
----	-----

To determine the present of subwoofer.

DIALOG

Drag the slider to adjust the level.
To adjust the volume of the dialog when playing DVD.

POST DRC

ON	OFF	AUTO
----	-----	------

To setup post DRC ratio of sound.
Default is "AUTO".

SPDIF SETUP
(Double tap to enter)

SPDIF OUTPUT

SPDIF OFF	Analog signal output
SPDIF / RAW	The original source code from DVD is delivered directly through digital port.
SPDIF / PCM	The code flow from disc will be decoded before it is encoded into PCM digital signal output. Select this option when DVD audio output analog signal is connected with 2-channel digital stereo amplifier.

The PCM channel entry setup can only be carried out when "SPDIF / PCM" is selected. If the sampling rate of LPCM of the disc is smaller than the sampling rate selected, the smaller output will be delivered. (For example, the output will be 48K if disc sampling rate is 48K even though 96K is selected.)

LPCM OUT

48K	To convert 96K LPCM to 48K LCPM. Choose this option when your power amplifier does not support 96K LPCM decoding.
96K	Select this to deliver the LPCM digital audio in true form output.

DOLBY DIGITAL SETUP
(Double tap to enter)

DUAL MONO

STEREO	R-MONO
L-MONO	MIX-MONO

DYNAMIC

Drag the slider to adjust the level. The greater the dynamic range compression rate will result in lesser dynamic range difference.

CHANNEL DELAY

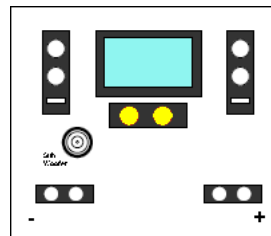

Tap the speaker you would like to set, then tap - to reduce and + to increase the speaker distance.

EQUALIZER
(Double tap to enter)

EQ TYPE

MONO	DANCE
ROCK	TECHNO
POP	CLASSIC
LIVE	SOFT

BASS BOOST

ON	OFF
----	-----

SUPER BASS

ON	OFF
----	-----

TREBLE BOOST

ON	OFF
----	-----

3D PROCESSING
(Double tap to enter)

PRO LOGIC II

PRO LOGIC II

ON
OFF
AUTO

MODE

MUSIC
MOVIE
PRO LOGIC
AUTO

PANORAMA

ON	OFF
----	-----

DIMENSION

SIZE -3
SIZE -2
SIZE -1
SIZE 0
SIZE 1
SIZE 2
SIZE 3

CENTER WIDTH

LEVEL 0
LEVEL 1
LEVEL 2
LEVEL 3
LEVEL 4
LEVEL 5
LEVEL 6
LEVEL 7

REVERB MODE

OFF	BATHROOM
CONCERT	CAVE
LIVING ROOM	ARENA
HALL	CHURCH

HDCD
(Double tap to enter)

FILTER

OFF	1X	2X
-----	----	----

To select sampling frequency for the digital wave filter. The tone quality is clearer and better with more sampling frequency. Default option is 1X. When playing HDCD, choose either 1X or 2X.

PREFERENCE PAGE

Preference page can only be displayed when no disc is detected in the system.

TV TYPE

PAL	MULTI	NTSC
-----	-------	------

To select video system type. NTSC is recommended.

PBC

ON	OFF
----	-----

To enable / disable the VCD playback control option. When ON is selected, the system will display PBC menu when playing VCD 2.0 and above.

AUDIO

ENGLISH	SWEDISH	JAPANESE	RUSSIAN
FRENCH	SPANISH	KOREAN	THAI
ITALIAN	CHINESE		

To select DVD playback language. (Disc support dependent)

SUBTITLE

ENGLISH	SWEDISH	JAPANESE	RUSSIAN
FRENCH	SPANISH	KOREAN	THAI
ITALIAN	CHINESE		

To select DVD subtitle language. (Disc support dependent)

DISC MENU

ENGLISH	SWEDISH	JAPANESE	RUSSIAN
FRENCH	SPANISH	KOREAN	THAI
ITALIAN	CHINESE		

To select DVD disc menu language. (Disc support dependent)

PARENTAL

KID SAFE	PG	PGR	NC 17
G	PG 13	R	ADULT

To set locking level of disc menu. You are required to provide password to change this setup. Turn to next page to learn about password setup under "PASSWORD SETUP PAGE".

DEFAULT

RESET

Tap this button to reset all media playback setup to factory setup.

PASSWORD SETUP PAGE

PASSWORD
MODE

ON
OFF

You are required to enter password in order to change the password mode. Use the remote control to enter the password.

PASSWORD

CHANGE

To change the password, you are required to provide the old password prior entering the new password. Use the remote control to enter the passwords. Default password is "1389".

Spectrum Display

When the system is left idle while playing music for 12 seconds, screen will change to spectrum display.

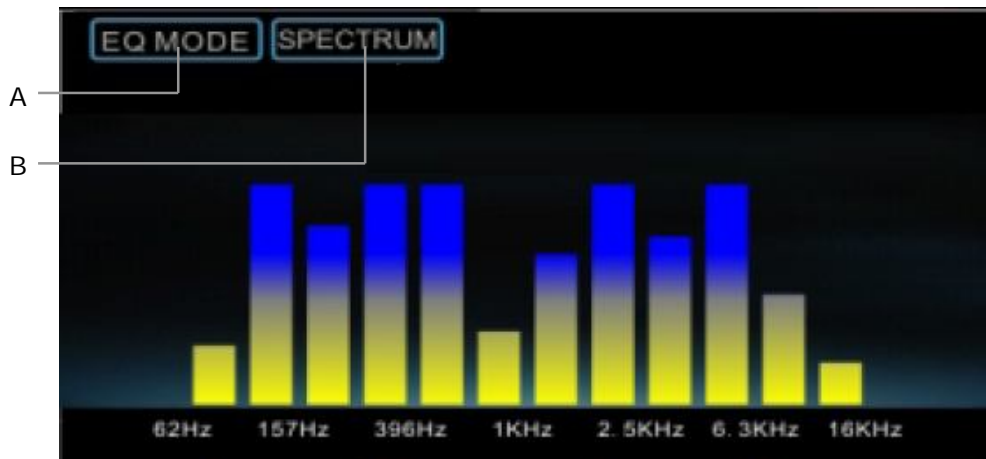

- A. Tap to select the desired equalizer mode between FLAT, CUSTOM, POP, ROCK, CLASSIC and JAZZ.
- B. Tap to select the desired spectrum theme.

Simply tap the screen (except **EQ MODE** or **SPECTRUM**) to go back to previous page.

VIR.CDC

The system allows you to rip an audio CD to its internal hard disk drive via VIR.CDC. After the audio CD is ripped, remove the audio CD from the system and you may play the songs from its internal hard disk drive. The ripped music files will be stored in MP3 format.

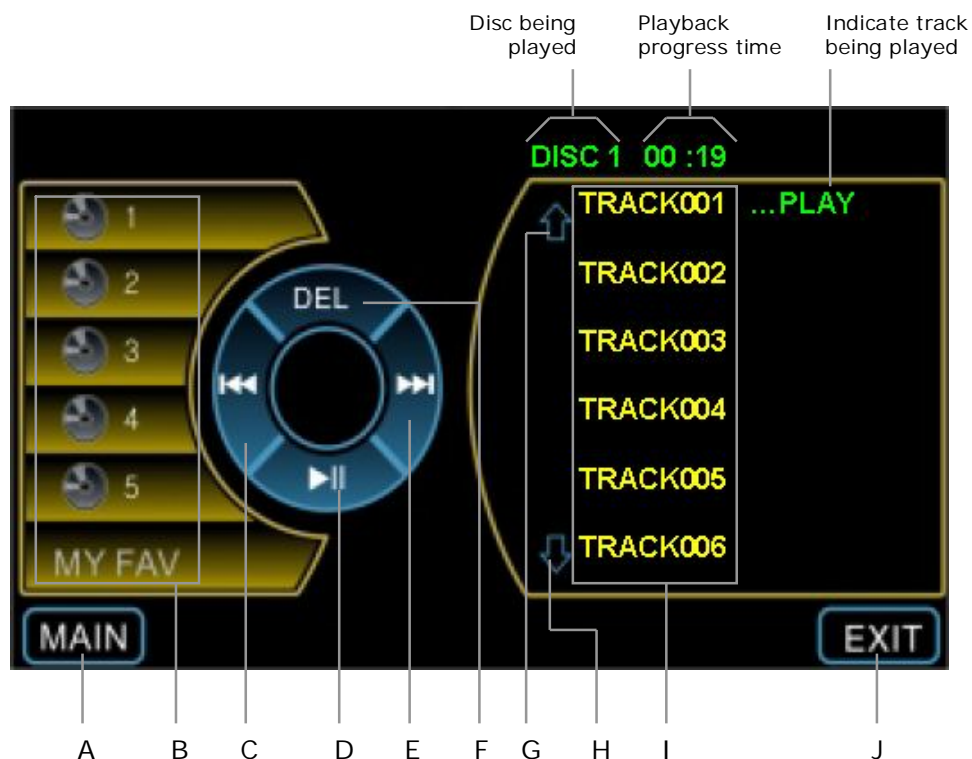

- A. Return to Main Menu.
- B. Hard disk's virtual CD. Select and tap the CD you would like to listen.
- C. Play previous track
- D. Play / Pause
- E. Play next track
- F. Delete selected track from hard disk.
To delete a track
 1. Tap **DEL**.
 2. Tap the track to be deleted.
 3. Tap **DEL** again to confirm the deletion.
- G. Page up
- H. Page down
- I. Track list
- J. Return to Spectrum display.

Ripping an audio CD to the system internal hard disk

1. Insert an audio CD to the system.
2. Tap the screen to display the media playback menu buttons as shown below.



3. Tap **SAVE**.

4. System will enter VIR.CDC ripping interface as below.

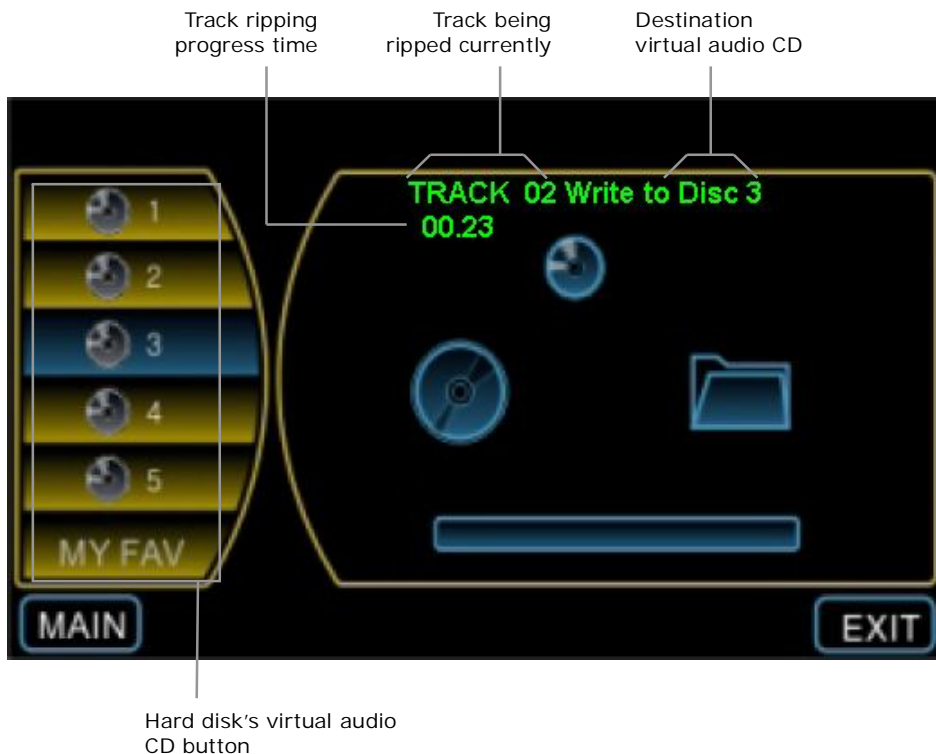

5. Select and tap virtual audio CD button to start ripping the audio CD. You may rip up to 5 audio CDs to the system. You may also rip selected song to **MY FAV**.

Note

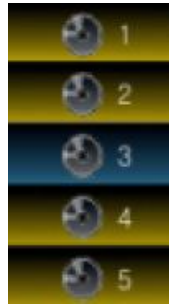

When an audio CD is ripped to the hard disk via virtual audio CD button 1 to 5, the system will rip the entire source audio CD starting from the first track.

However, if **MY FAV** is selected, the system will only rip the song that is currently being played. You may rip up to 60 songs.

To stop ripping, tap **EXIT** twice.

RADIO

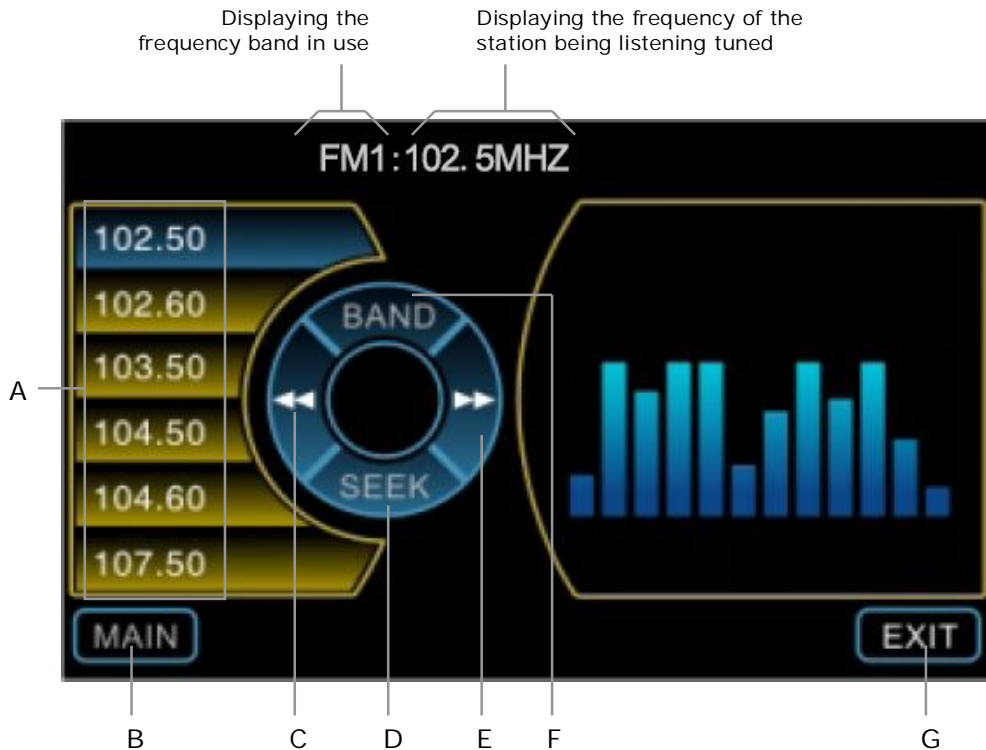

- A. Preset stations. To save a station, tune to the desired frequency using search station button (C) or (D) then tap and hold the preset station button for 2 seconds to save the station. To tune to the saved station, simply tap the preset station.
- B. Return to Main Menu.
- C. Auto tuning (frequency in ascending order). Tap once and the tuner will search the next available station by frequency in ascending order.
- D. Search stations and save automatically. Tap this button and system will search for all available station and saving it to preset stations automatically.
- E. Auto tuning (frequency in descending order). Tap once and the tuner will search the next available station by frequency in descending order.
- F. To select the frequency band. There are 3 FM bands (FM1, FM2 and FM3) and 1 AM band. Each band contains 6 stations.
- G. Return to previous function.

SET

System setup

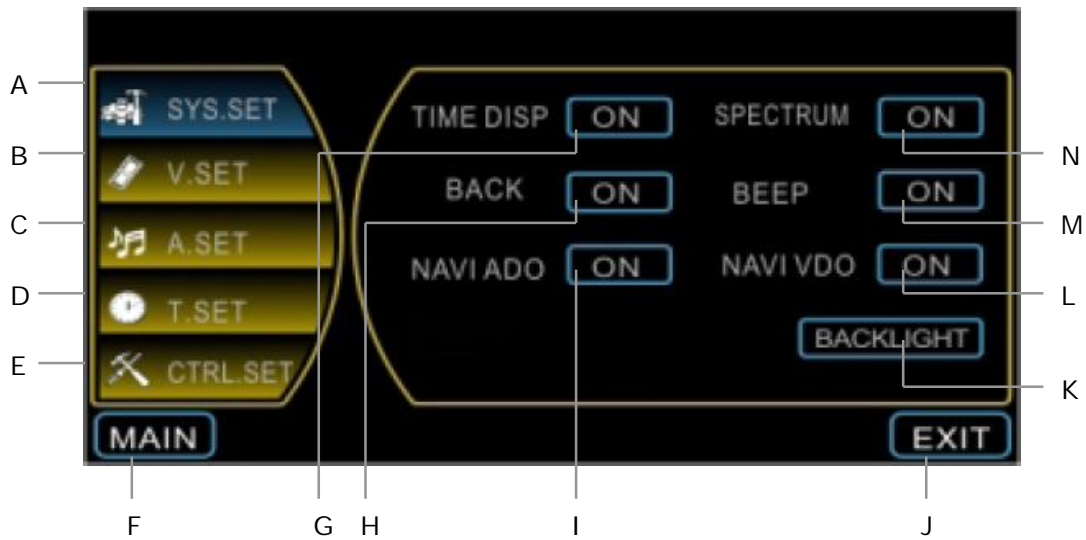

- A. System setup
- B. Video setup
- C. Audio setup
- D. Time setup
- E. Control setup
- F. Return to Main Menu.
- G. Time Display. Select ON to allow the time to be displayed on the screen.
- H. *To activate rear camera. * This function is not available.*
- I. When this function is enabled, the system will play music file whenever there's no turn instruction given by the navigation software during navigation.
- J. Return to previous function.

- K. To set the colour of the system's hardware button backlight.

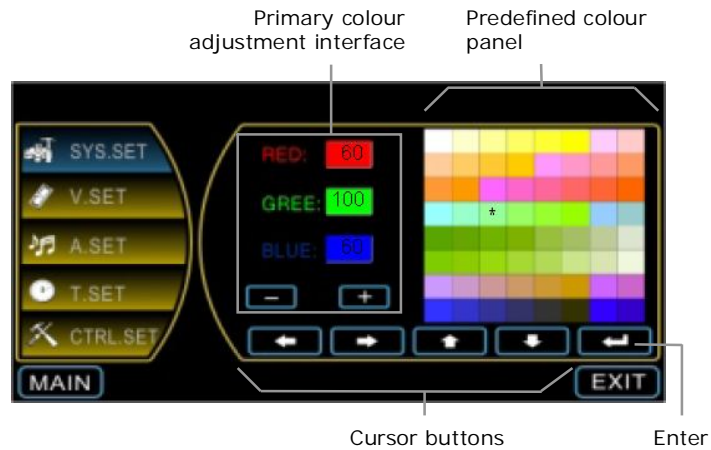

You may select the desired colour from the predefined colour panel. To select a colour, use the cursor buttons to move the asterisk symbol to the desired colour. Then, tap Enter. Alternatively, you may tap the desired colour at the predefined colour panel for quicker selection.

You may also customize your own colour which is not listed in the predefined colour panel by using the primary colour adjustment interface. Tap the respective colour box (with numerical figure), then tap **-** to reduce and **+** to increase its value.

- L. When this function is enabled, the system will play video file whenever there's no turn instruction given by the navigation software during navigation.
- M. Beeping sound when menu buttons are tapped.
- N. Tap ON to display Spectrum page when music files are played. Please go to page 30 for details.

Video setup

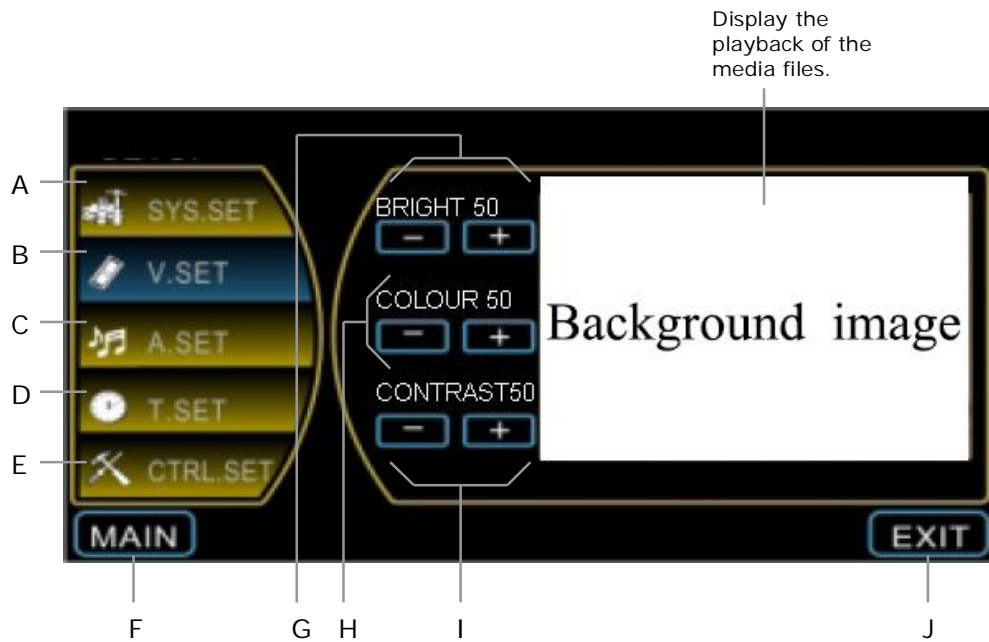

- A. System setup
- B. Video setup
- C. Audio setup
- D. Time setup
- E. Control setup
- F. Return to Main Menu.
- G. To set the brightness of the playback videos and images. Tap **-** to reduce the brightness and **+** to increase it.
- H. To set the colour intensity of the playback videos and images. Tap **-** to reduce the colour intensity and **+** to increase it.
- I. To set the contrast of the playback videos and images. Tap **-** to reduce the contrast and **+** to increase it.
- J. Return to previous function.

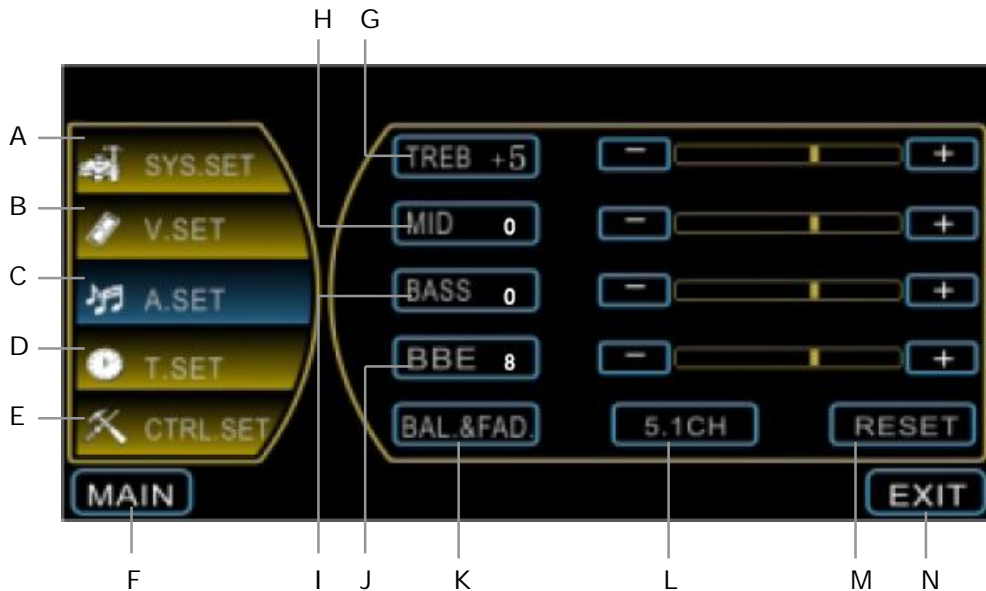

Audio setup

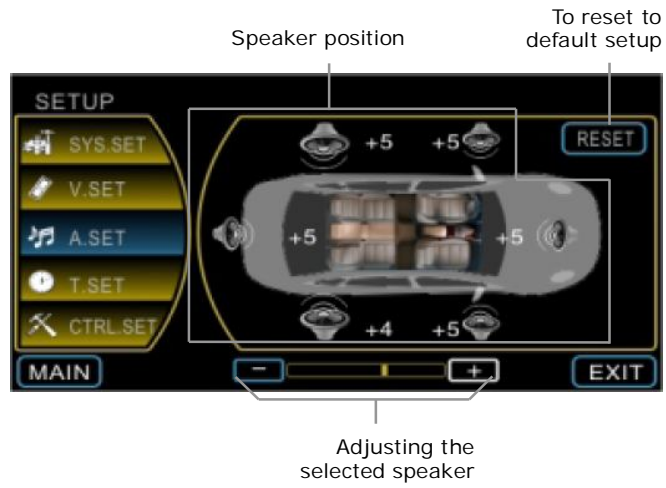

- A. System setup
- B. Video setup
- C. Audio setup
- D. Time setup
- E. Control setup
- F. Return to Main Menu.
- G. Treble. Tap **-** to reduce and **+** to increase it.
- H. Mid. Tap **-** to reduce and **+** to increase it.
- I. Bass. Tap **-** to reduce and **+** to increase it.
- J. Stands for Barcus-Berry Electronics. Employing BBE Sound technology to improve the sound quality. Tap **-** to reduce and **+** to increase it.

K. Balance & fading



To adjust, select and tap the speaker icon  of the desire position. Then, tap  or  to adjust.

L. To enable or disable 5.1 channel surround sound capability.

M. Reset. Tap this button to reset all audio setup to its original setup.

N. Return to previous function.

Time setup

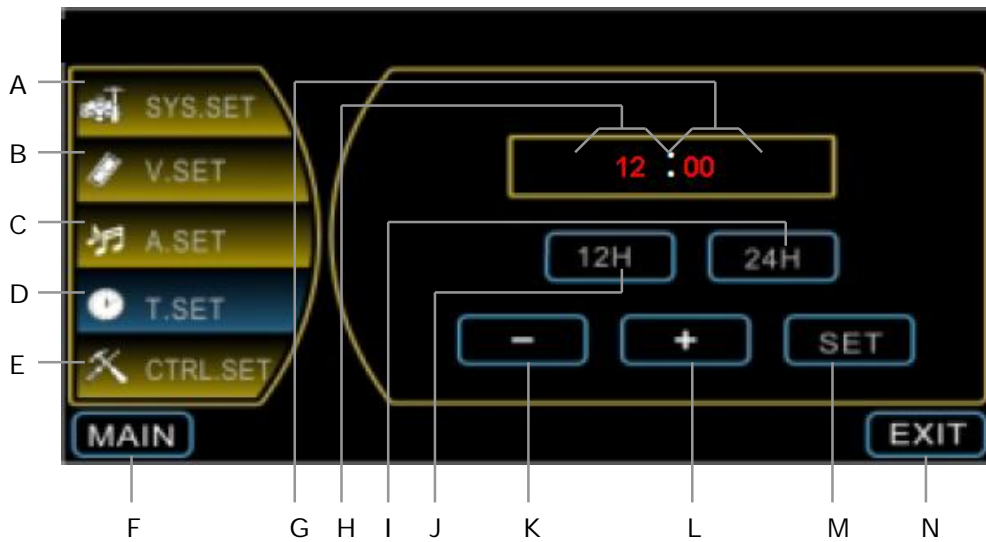

- A. System setup
- B. Video setup
- C. Audio setup
- D. Time setup
- E. Control setup
- F. Return to Main Menu.
- G. Minute display
- H. Hour display
- I. Displays the time in 24 hour system.
- J. Displays the time in 12 hour system.
- K. Tap to adjust the hour or minute in descending order.
- L. Tap to adjust the hour or minute in ascending order.
- M. Tap to confirm the adjusted time.
- N. Return to previous function.

Adjusting the time

1. To adjust the "minute", tap (G). The "minute" display will blink. Tap (K) or (L) to adjust.
2. To adjust the "hour", tap (H). The "hour" display will blink. Tap (K) or (L) to adjust.
3. Finally, tap (M) to confirm the setup.

Control setup

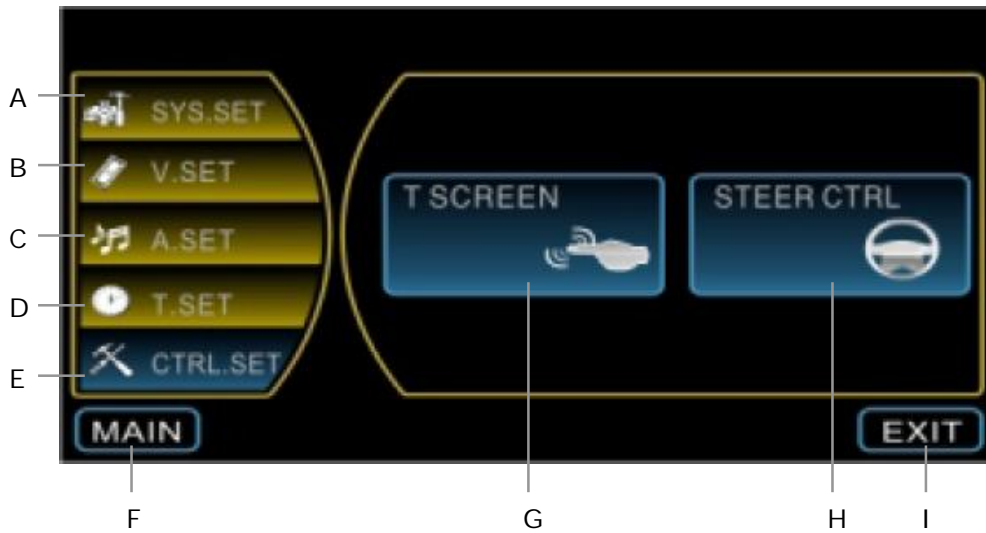

- A. System setup
- B. Video setup
- C. Audio setup
- D. Time setup
- E. Control setup
- F. Return to Main Menu.
- G. Touch screen calibration

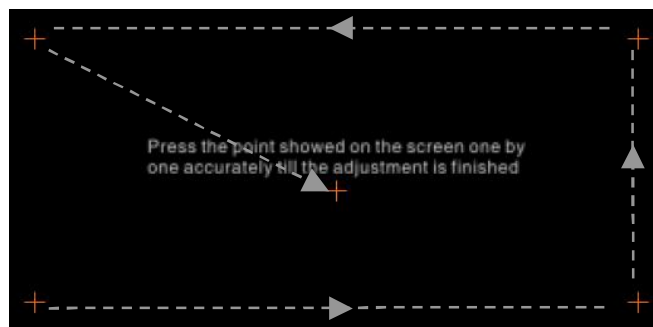

Please perform screen calibration to correct the preciseness of the touch screen. Press and briefly hold a stylus or any similar non-marking instrument to the center of the target. Repeat as the target moves around the screen. When the calibration is completed, simply tap anywhere on the screen to exit.

- H. *Steering control calibration. * This function is not available.*
- I. Return to previous function.

Connection Diagram

- Please ensure that all wires are connected to the correct interface as shown in this connection diagram.
- Please cover the audio and video's insulation casing to prevent short-circuit.

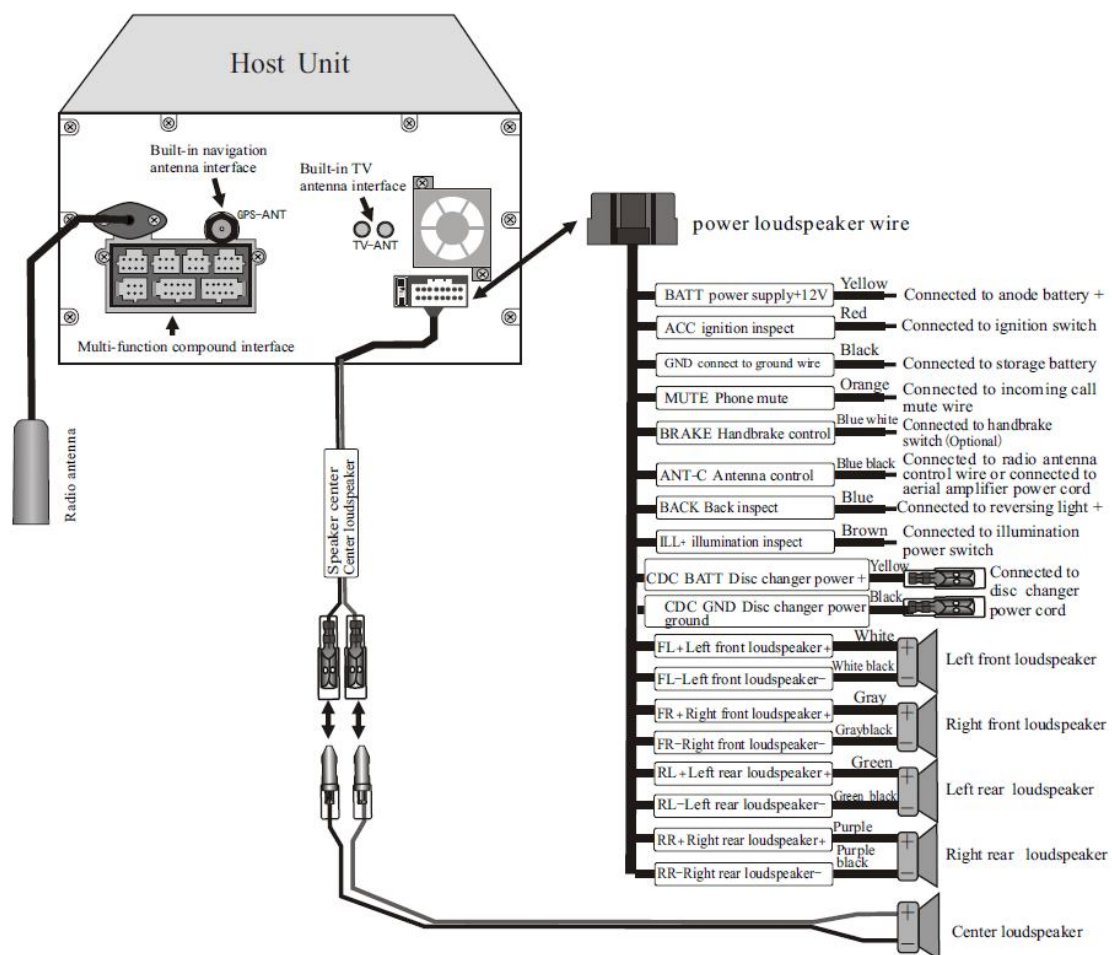

Multi-function compound interface

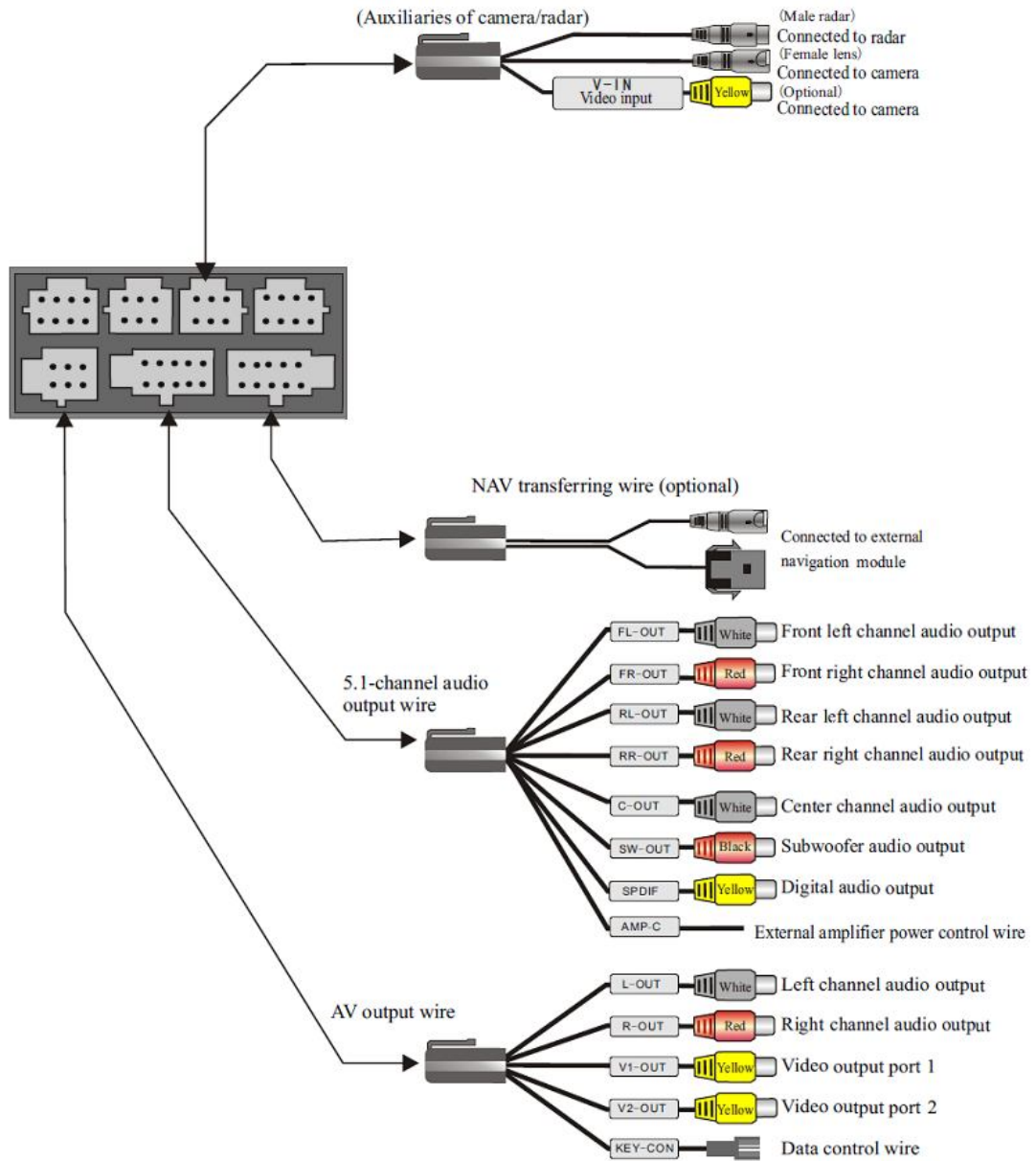

Specifications

System	Working voltage	DC 11V-15V
	Working current	max 15A
	Standby current	< 6mA
	Working temperature	-20 to 60°C
	Reserve temperature	-30 to 80°C
	Video system	Auto PAL / NTSC
	Screen dimensions	143.40 (W) x 79.20 (H) mm 800 x 480 pixels
	Weight	2.8kg
	Media storage	Disc (DVD, VCD & audio CD), SDMMC card and USB flash drive. Max 2GB.
Radio	Frequency range	FM 87.50MHz to 108MHz AM 522kHz to 1620kHz
	Station preset	18 FM stations 6 AM stations
	Search mode	Automatic / Manual
DVD	Video output	1 ± 0.2Vp-p (75Ω)
	Disc	Diameter 12cm
	Compatible format	DVD / VCD / Audio CD / MP3 / WMA / JPEG
Audio	Channel imbalance	< 2dB
	Separation	> 45dB
	Frequency response	20Hz ~ 20KHz (± 3dB)
	Tone control	Bass 100KHz ± 8dB Mid 1KHz ± 8dB Treble 10KHz ± 8dB
Amplifier	Test voltage	13.8V
	Max output power	5 X 45W
	Speaker resistance	4 Ω (4-8 Ω could be accepted)
GPS	GPS Frequency	1.57524GHz
	Channels	50
	Sensitivity	- 160 dBm
	Precision	Position: < 10 meters
	Capture time	Hot start: ≤ 2 sec, average Warm start: ≤ 30 sec, average Cold start: ≤ 30 sec, average
	Refreshing rate	1/sec

For the latest version of this manual, please
visit www.lokatoo.com

Amtel Cellular Sdn Bhd (278151-D)
No 5, Jalan PJS 7/19, Bandar Sunway,
46150 Petaling Jaya, Selangor D.E., Malaysia.
Tel: 03-5632 6788 Fax: 03-5632 5678
E-mail: customerservice@lokatoo.com
Customer Service Hotline: 1 800 88 0308